



Name of the Bundle	Proficient & Advanced Bundle V2	Subject	APTITUDE
Topic	DIRECTION SENSE TEST	Last updated on	23 January 2024

CONCEPT 1 – BASIC DIRECTION BASED QUESTION

- 1) Anil is to the east of Dev and to the north of Esha. If Gugan is in the south of Esha, then Anil is in which direction with respect to Gugan?
- North.
 - South.
 - East.
 - West.

ANS: a) North.

Explanation:

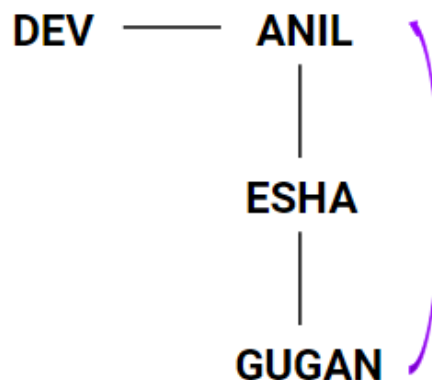
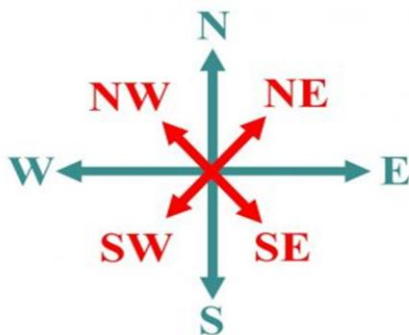

Therefore, Anil is in the North of Gugan.



Name of the Bundle	Proficient & Advanced Bundle V2	Subject	APTITUDE
Topic	DIRECTION SENSE TEST	Last updated on	23 January 2024

CONCEPT 2 – CHANGE OF DIRECTION

2) If South-West becomes North, then what will North-East be?

- a) North.
- b) South-East.
- c) South.
- d) East.

ANS: c) South.

Explanation:

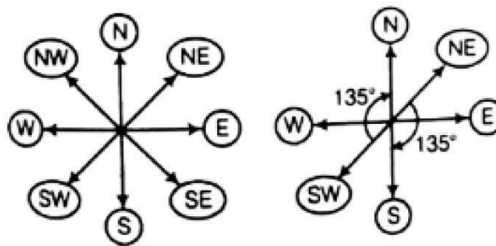

Clearly, directions are moving 135° clockwise. Hence, North -East will become South moving 135° clockwise.

3) If South-east becomes North, North-east becomes west and so on what will west become?

- a) North-East.
- b) North-West.
- c) South-west.
- d) South-east.

ANS: d) South-east.

Explanation:

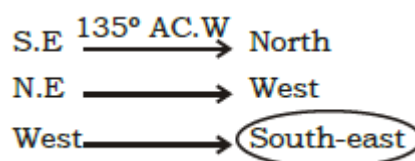



Name of the Bundle	Proficient & Advanced Bundle V2	Subject	APTITUDE
Topic	DIRECTION SENSE TEST	Last updated on	23 January 2024

4) If South-east becomes Southwest, then South becomes ?

- a) East.
- b) West.
- c) North.
- d) South.

ANS: b) West.

Explanation:

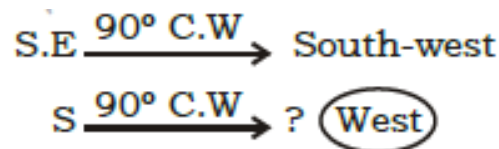

CONCEPT 3 – WRONG DIRECTION

5) At a crossing, there was a direction pole, which was showing all the four correct directions. But due to the wind, it turns in such a manner that now the West pointer is showing South. Harish went in the wrong direction thinking that he was travelling East. In what direction he was actually travelling?

- a) South
- b) North
- c) West
- d) East

ANS: b) North.

Explanation:

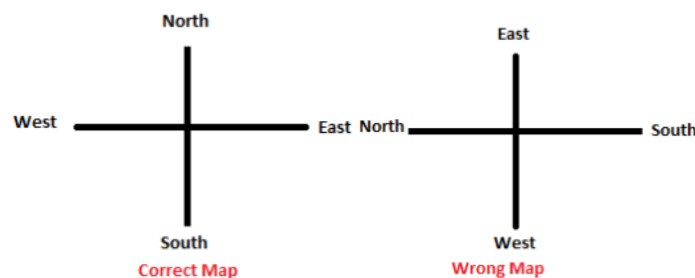

According to the wrong Map, Harish was travelling in the NORTH direction.



Name of the Bundle	Proficient & Advanced Bundle V2	Subject	APTITUDE
Topic	DIRECTION SENSE TEST	Last updated on	23 January 2024

CONCEPT 4 – ANSS BASED ON DIRECTION ONLY

6) A man walks in straight 100 m and turns to his right and walks 75 m. Again he turns to his right and walks 100 m. And last he turned left and walked 25 m. Now he is walking in the north direction. Then find from which direction he started?

- a) North.
- b) South.
- c) West.
- d) East.

ANS: c) West.

Explanation:

When distance is not asked in question, we can use the trick it will be useful.

R – Right (+ 90° clockwise); L - Left (-90° Anti-clockwise)

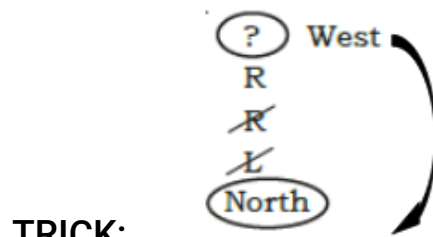
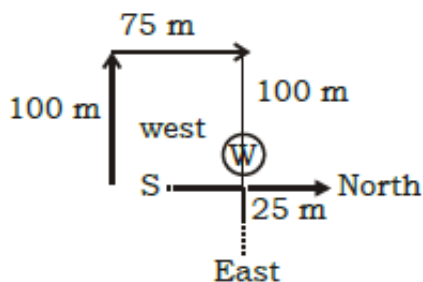

Right to the starting direction is North means, Left to the Ending direction would be the starting direction which is West.



Name of the Bundle	Proficient & Advanced Bundle V2	Subject	APTITUDE
Topic	DIRECTION SENSE TEST	Last updated on	23 January 2024

7) Mr Deepak Mohan walks 5 km towards the south and then turns to the right. After walking 3 km he turns to the left and walks 5 km. What direction is he facing right now?

- a) West.
- b) South.
- c) North-East.
- d) South-West.

ANS:b) South.

Explanation:

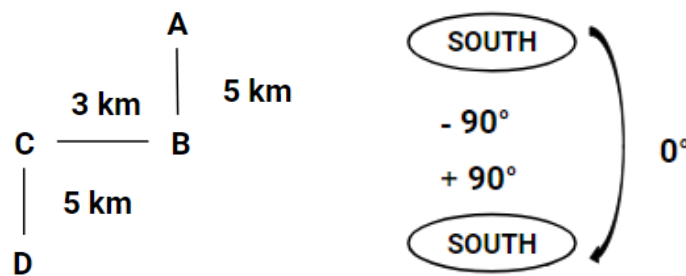

Now, he is facing South.



Name of the Bundle	Proficient & Advanced Bundle V2	Subject	APTITUDE
Topic	DIRECTION SENSE TEST	Last updated on	23 January 2024

8) A man walking towards north after walking 100 m turns right and walks 75 m again he turns right and walks 100 m and in the last movement he turns left and walks 25 m. As of now in which direction he is walking?

- a) North. b) East. c) South. d) West.

ANS: b) East.

Explanation:

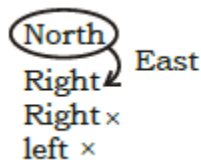

9) A man walks in the south direction. After he walks 1 km he turns his right 45° and walks 2 km again he turns his right and walks the same distance. Now find that in which direction he is going?

- a) South-East.
b) North-West.
c) North-East.
d) South-West.

ANS: b) North-West.

Explanation:

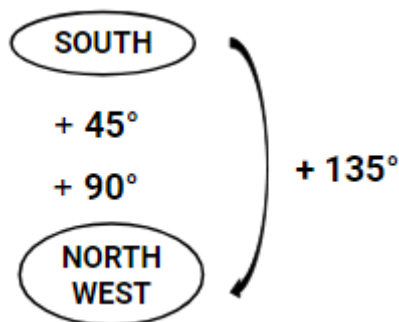



Name of the Bundle	Proficient & Advanced Bundle V2	Subject	APTITUDE
Topic	DIRECTION SENSE TEST	Last updated on	23 January 2024

CONCEPT 5 – ANSS BASED ON DISPLACEMENT ONLY

10) Anamika is facing South. She turns 90 degrees in the anticlockwise direction and then another 90 degrees in clock-wise direction. Find which direction she is facing now.

- a) East.
- b) South.
- c) South-East.
- d) South-West.

ANS: b)South.

Explanation:

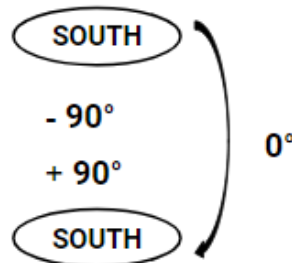



Name of the Bundle	Proficient & Advanced Bundle V2	Subject	APTITUDE
Topic	DIRECTION SENSE TEST	Last updated on	23 January 2024

11) Elangovan is facing East. He turns 45 degrees in the anticlockwise direction and then another 90 degrees in clock-wise direction. Find which direction he is facing now.

- a) East. b) South. c) South-East. d) North-East.

ANS: c) South-East.

Explanation:

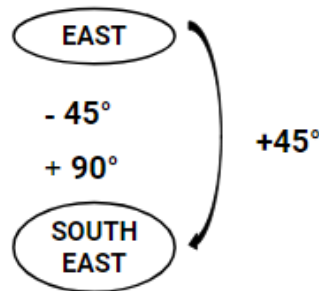

12) Vijay travelled 12 km Southward, then turned right and travelled 10 km, then turned right and travelled 12 km. How far was Vijay from the starting point?

- a) 22 km.
b) 44 km.
c) 12 km.
d) 10 km.

ANS: d) 10 km.

Explanation:

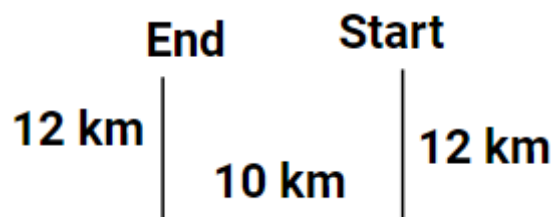

Therefore, Vijay was 10 km away from the starting point.



Name of the Bundle	Proficient & Advanced Bundle V2	Subject	APTITUDE
Topic	DIRECTION SENSE TEST	Last updated on	23 January 2024

CONCEPT 6 – ANS BASED ON DIRECTION AND DISPLACEMENT ONLY

13) Sowmya Krishnan walked 20 km towards the north. Then she turned right and walked 30 km. Then she turns right and walks 35 km. Then she turns left and walks 15 km. Finally she turns left and walks 15 km. In which direction and how many meters is she from the starting position?

- a) 15 km West.
- b) 30 km East.
- c) 30 km West.
- d) 45 km East.

ANS: d) 45 km East.

Explanation:

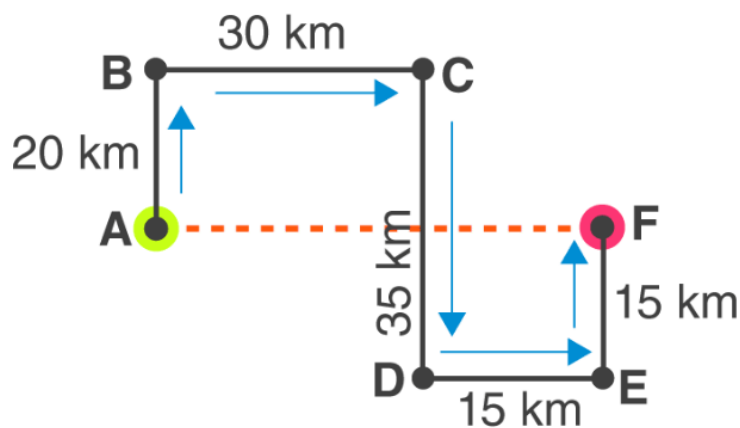

Therefore, F is 45 km and in the East direction from A.



Name of the Bundle	Proficient & Advanced Bundle V2	Subject	APTITUDE
Topic	DIRECTION SENSE TEST	Last updated on	23 January 2024

14) A is 6 km West from B. And C is 4 km north to B. D is 12 km south from C. Now D in which direction and how far from A.

- a) South-East, 10 km.
- b) South-East, 15 km.
- c) North-East, 10 km.
- d) North-East, 15 km.

ANS: a) South-East, 10 km.

Explanation:

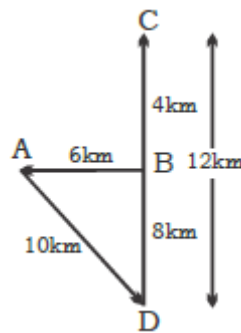

$$BD = 8 \text{ km} ; BA = 6 \text{ km}$$

$$AD = \sqrt{(8)^2 + (6)^2} = \sqrt{64 + 36} = \sqrt{100} = 10 \text{ km}$$

Therefore, D is 10 km and in the South-East direction from A.



Name of the Bundle	Proficient & Advanced Bundle V2	Subject	APTITUDE
Topic	DIRECTION SENSE TEST	Last updated on	23 January 2024

CONCEPT 7 – CLOCK BASED PROBLEM

15) It is 4:30 O' clock if at this time the hour hand points towards South-west then in which direction minute would be?

- a) East.
- b) North.
- c) West.
- d) South.

ANS: c) West.

Explanation:

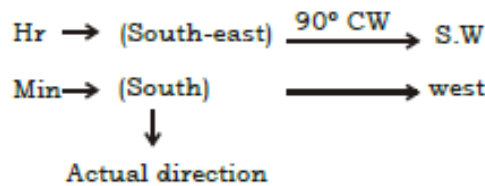

16) It is 9 O' clock, if at this time the hour hand points towards South-west then in which direction Minute would be?

- a) South-East.
- b) North-West.
- c) North-East.
- d) South-West.

ANS: b) North-West.

Explanation:

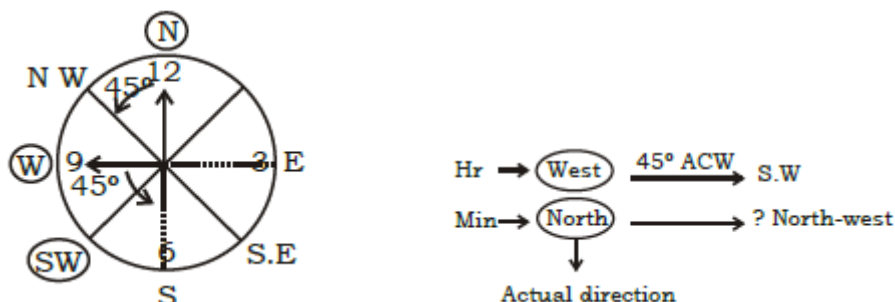



Name of the Bundle	Proficient & Advanced Bundle V2	Subject	APTITUDE
Topic	DIRECTION SENSE TEST	Last updated on	23 January 2024

17) A clock is so placed that at 12 noon its minute hand points towards the North-East. In which direction does its hour hand point at 1:30 pm?

- a) North.
- b) South.
- c) East.
- d) West.

ANS: c) East.

Explanation:

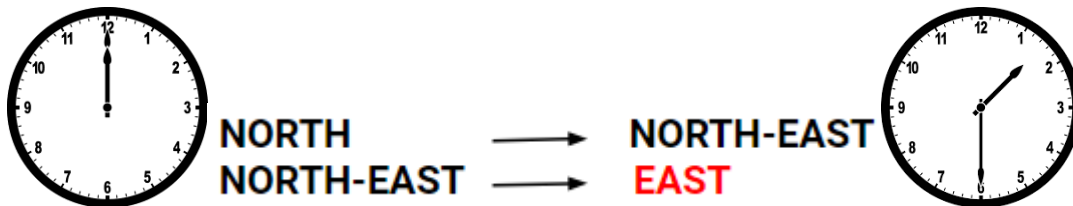



Name of the Bundle	Proficient & Advanced Bundle V2	Subject	APTITUDE
Topic	DIRECTION SENSE TEST	Last updated on	23 January 2024

CONCEPT 8 – SHADOWS BASED PROBLEM

18) One morning after sunrise, Nandita and Ravi were sitting in a lawn with their backs towards each other. Nandita's shadow fell exactly towards her left-hand side. Which direction was Ravi facing?

- a) North.
- b) South.
- c) East.
- d) West.

ANS: b) South.

Explanation:

Direction vs Time	Morning	Evening
North	Left	Right
South	Right	Left
East	Back	Front
West	Front	Back

Since it was morning and Nandita's shadow fell exactly to her left-hand side, Nandita was facing North and hence Ravi should be facing South. Hence the ANS is option B.



Name of the Bundle	Proficient & Advanced Bundle V2	Subject	APTITUDE
Topic	DIRECTION SENSE TEST	Last updated on	23 January 2024

19) At sunrise, Rohit and Mohit are having a conversation standing in front of each other. The shadow of Mohit is formed towards the right hand of Rohit. What direction is Mohit facing?

- a) North.
- b) South.
- c) East.
- d) West.

ANS: a) North.

Explanation:

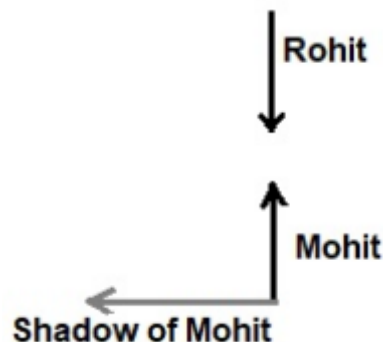

Hence, Mohit is facing the NORTH direction.



Name of the Bundle	Proficient & Advanced Bundle V2	Subject	APTITUDE
Topic	DIRECTION SENSE TEST	Last updated on	23 January 2024

CONCEPT 9 – MISCELLANEOUS

20) A river flows West to East and on the way turns left and goes in a semi-circle around a hillock and then turns left at right angles. In which direction is the river finally following?

- a) East.
- b) West.
- c) North.
- d) South.

ANS: a) East.

Explanation:

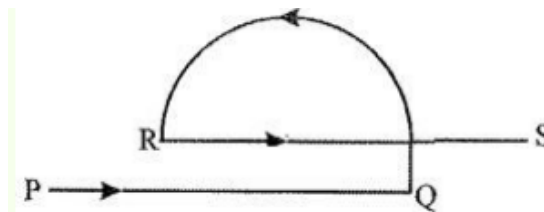

Hence, the river is finally flowing towards the East.